

Approval body for construction products
and types of construction

Bautechnisches Prüfamt

An institution established by the Federal and
Laender Governments



European Technical Assessment

ETA-09/0350
of 12 December 2017

English translation prepared by DIBt - Original version in German language

General Part

Technical Assessment Body issuing the
European Technical Assessment:

Deutsches Institut für Bautechnik

Trade name of the construction product

Injection system VME for concrete

Product family
to which the construction product belongs

Injection system for use in concrete

Manufacturer

MKT
Metall-Kunststoff-Technik GmbH & Co. KG
Auf dem Immel 2
67685 Weilerbach
DEUTSCHLAND

Manufacturing plant

Werk 1,D und Werk 2, D

This European Technical Assessment
contains

25 pages including 3 annexes which form an integral part
of this assessment

This European Technical Assessment is
issued in accordance with Regulation (EU)
No 305/2011, on the basis of

ETAG 001 Part 5: "Bonded anchors", April 2013,
used as EAD according to Article 66 Paragraph 3 of
Regulation (EU) No 305/2011.

This version replaces

ETA-09/0350 issued on 24 November 2014

European Technical Assessment

ETA-09/0350

English translation prepared by DIBt

Page 2 of 25 | 12 December 2017

The European Technical Assessment is issued by the Technical Assessment Body in its official language. Translations of this European Technical Assessment in other languages shall fully correspond to the original issued document and shall be identified as such.

Communication of this European Technical Assessment, including transmission by electronic means, shall be in full. However, partial reproduction may only be made with the written consent of the issuing Technical Assessment Body. Any partial reproduction shall be identified as such.

This European Technical Assessment may be withdrawn by the issuing Technical Assessment Body, in particular pursuant to information by the Commission in accordance with Article 25(3) of Regulation (EU) No 305/2011.

Specific Part

1 Technical description of the product

The "Injection system VME for concrete" is a bonded anchor consisting of a cartridge with injection mortar VME or VM-ME and a steel element. The steel element consist of a threaded rod with washer and hexagon nut in the range of M8 to M30, reinforcing bar in the range of diameter Ø8 to Ø32 mm or internal threaded rod VMU-IG-M6 to VMU-IG-M20.

The steel element is placed into a drilled hole filled with injection mortar and is anchored via the bond between metal part, injection mortar and concrete.

The product description is given in Annex A.

2 Specification of the intended use in accordance with the applicable European Assessment Document

The performances given in Section 3 are only valid if the anchor is used in compliance with the specifications and conditions given in Annex B.

The verifications and assessment methods on which this European Technical Assessment is based lead to the assumption of a working life of the anchor of at least 50 years. The indications given on the working life cannot be interpreted as a guarantee given by the producer, but are to be regarded only as a means for choosing the right products in relation to the expected economically reasonable working life of the works.

3 Performance of the product and references to the methods used for its assessment

3.1 Mechanical resistance and stability (BWR 1)

Essential characteristic	Performance
Characteristic resistance for static and quasi-static action and seismic performance categories C1, C2	See Annex C 1 to C 7
Displacements	See Annex C 8 to C 10

3.2 Safety in case of fire (BWR 2)

Essential characteristic	Performance
Reaction to fire	Anchorage satisfy requirements for Class A1
Resistance to fire	No performance assessed

3.3 Hygiene, health and the environment (BWR 3)

Regarding dangerous substances there may be requirements (e.g. transposed European legislation and national laws, regulations and administrative provisions) applicable to the products falling within the scope of this European Technical Assessment. In order to meet the provisions of Regulation (EU) No 305/2011, these requirements need also to be complied with, when and where they apply..

3.4 Safety in use (BWR 4)

The essential characteristics regarding Safety in use are included under the Basic Works Requirement Mechanical resistance and stability.

English translation prepared by DIBt

4 Assessment and verification of constancy of performance (AVCP) system applied, with reference to its legal base

In accordance with guideline for European technical approval ETAG 001, April 2013, used as European Assessment Document (EAD) according to Article 66 Paragraph 3 of Regulation (EU) No 305/2011, the applicable European legal act is: [96/582/EC].

The system to be applied is: 1

5 Technical details necessary for the implementation of the AVCP system, as provided for in the applicable European Assessment Document

Technical details necessary for the implementation of the AVCP system are laid down in the control plan deposited at Deutsches Institut für Bautechnik.

Issued in Berlin on 12 December 2017 by Deutsches Institut für Bautechnik

BD Dipl.-Ing. Andreas Kummerow
Head of Department

beglaubigt:
Baderschneider

Installation threaded rod M8 to M30

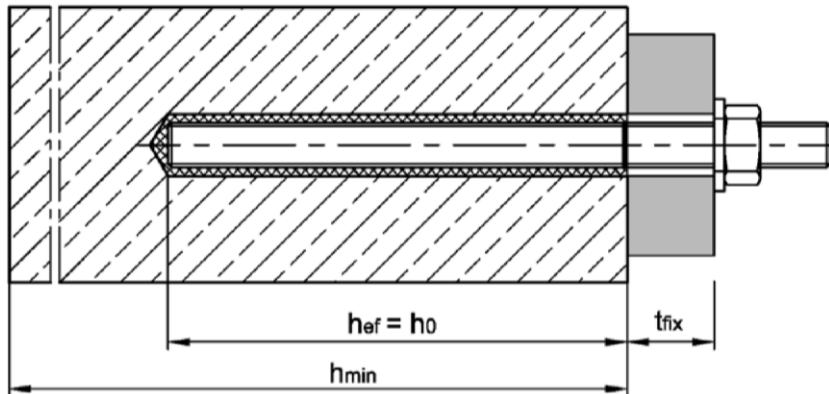

Installation internally threaded anchor rod VMU-IG M6 to VMU-IG M20

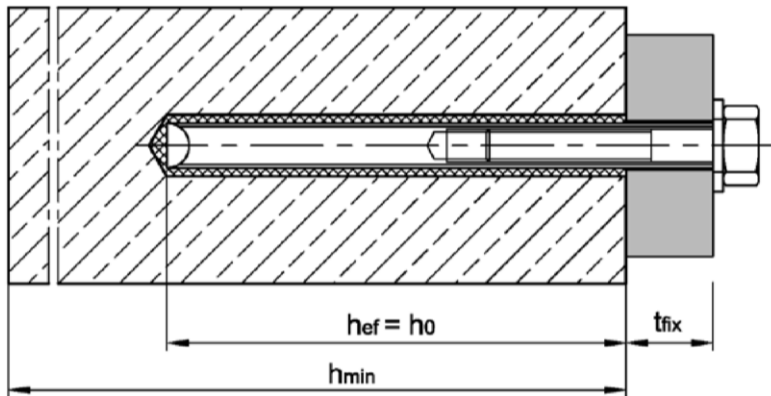

Installation reinforcing bar Ø8 to Ø32

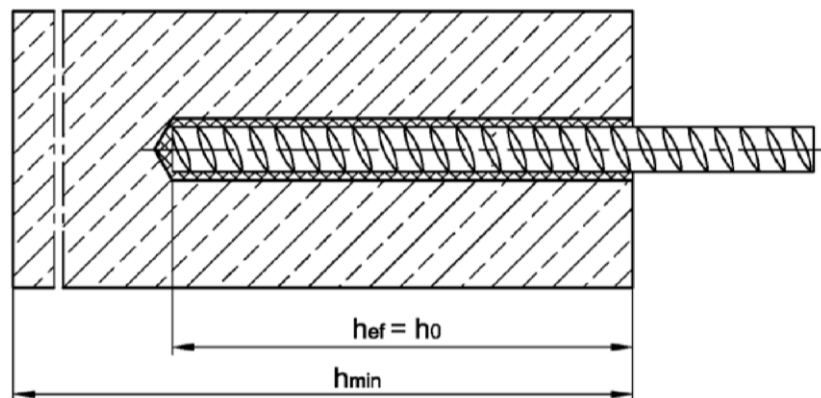

- t_{fix} = thickness of fixture
- h_{ef} = effective anchorage depth
- h_0 = depth of drill hole
- h_{min} = minimum thickness of member

Injection System VME for concrete

Product description
Installed condition

Annex A1

Cartridge: Injection Adhesive VME or Injection Adhesive VM-ME

385ml, 444ml, 585ml, 999ml and 1400ml injection mortar cartridge (Type: "side-by-side")

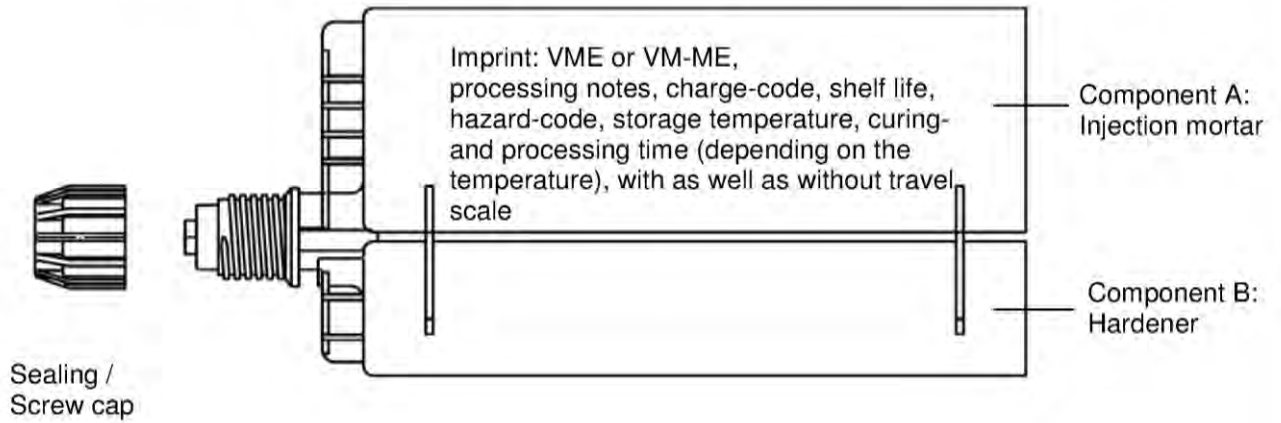

Static Mixer

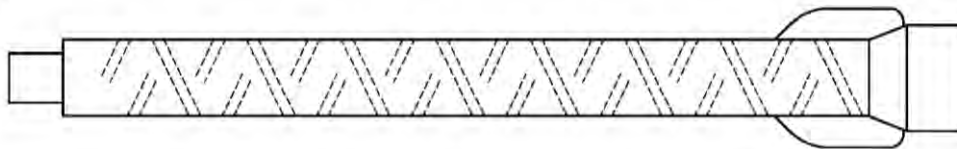

Injection System VME for concrete

Product description
Cartridge and static mixer

Annex A2

Threaded rod

Threaded rod VMU-A, V-A with washer and hexagon nut
M8, M10, M12, M16, M20, M24, M27, M30

Threaded rod VM-A (material sold by the metre, to be cut at the required length)
M8, M10, M12, M16, M20, M24, M27, M30

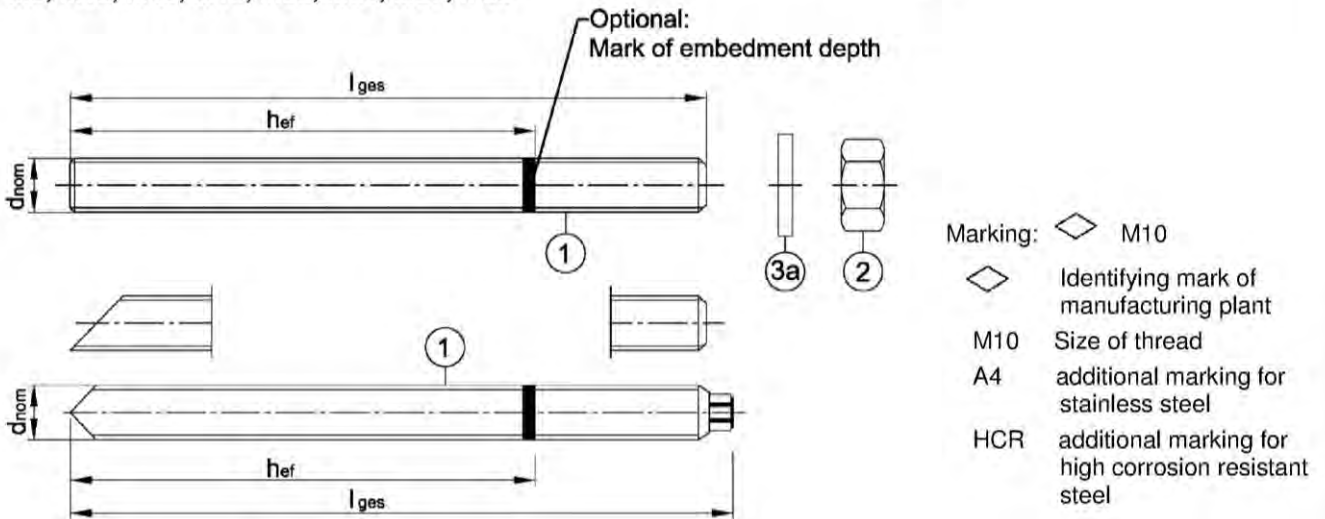

Commercial standard threaded rod with:

- Materials, dimensions and mechanical properties see Table A1
- Inspection certificate 3.1 acc. to EN 10204:2004

Washer with bore and reducing adapter for filling the gap between threaded rod and fixture

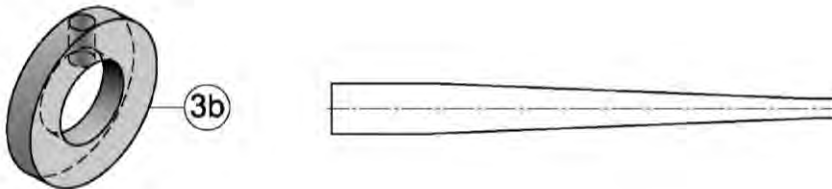

Internally threaded anchor rod

VMU-IG M6, VMU-IG M8, VMU-IG M10, VMU-IG M12, VMU-IG M16, VMU-IG M20

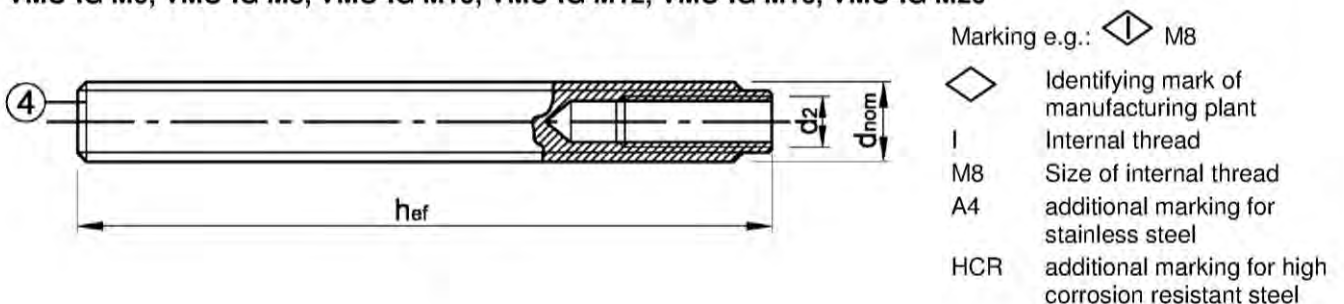

Injection System VME for concrete

Product description

Threaded rod and internally threaded anchor rod

Annex A3

Table A1: Materials

Part	Designation	Material	
Steel, zinc plated			
electroplated $\geq 5 \mu\text{m}$ acc. to EN ISO 4042:1999 or hot-dip galvanised $\geq 40 \mu\text{m}$ acc. to EN ISO 1461:2009 EN ISO 10684:2004+AC:2009 or sherardized $\geq 40\mu\text{m}$ acc. to EN ISO 17668:2016			
1	Threaded rod	Property class 4.6	$f_{uk} \geq 400 \text{ N/mm}^2$; $f_{yk} \geq 240 \text{ N/mm}^2$; $A_5 > 8 \%$ fracture elongation
		Property class 4.8	$f_{uk} \geq 400 \text{ N/mm}^2$; $f_{yk} \geq 320 \text{ N/mm}^2$; $A_5 > 8 \%$ fracture elongation
		Property class 5.6	$f_{uk} \geq 500 \text{ N/mm}^2$; $f_{yk} \geq 300 \text{ N/mm}^2$; $A_5 > 8 \%$ fracture elongation
		Property class 5.8	$f_{uk} \geq 500 \text{ N/mm}^2$; $f_{yk} \geq 400 \text{ N/mm}^2$; $A_5 > 8 \%$ fracture elongation
		Property class 8.8	$f_{uk} \geq 800 \text{ N/mm}^2$; $f_{yk} \geq 640 \text{ N/mm}^2$; $A_5 > 12 \%$ fracture elongation ¹⁾
EN 10087:1998, EN 10263:2001; Commercial standard threaded rod: EN ISO 898-1:2013			
2	Hexagon nut	Steel, zinc plated Property class 4 (for class 4.6 or 4.8 rod) Property class 5 (for class 5.6 or 5.8 rod) Property class 8 (for class 8.8 rod)	EN ISO 898-2:2012
3a	Washer	Steel, zinc plated (e.g.: EN ISO 7089:2000, EN ISO 7093:2000 or EN ISO 7094:2000)	
3b	Washer with bore	Steel, zinc plated	
4	Internally threaded anchor rod	Steel, electroplated, $A_5 > 8 \%$ fracture elongation Property class 5.8 and 8.8	EN 10087:1998
Stainless steel A4			
1	Threaded rod	Material 1.4401 / 1.4404 / 1.4571 / 1.4578 / 1.4362 / 1.4062	EN 10088-1:2014
		Property class 50	$f_{uk} = 500 \text{ N/mm}^2$; $f_{yk} = 210 \text{ N/mm}^2$; $A_5 > 12\%$ fracture elongation ¹⁾
		Property class 70	$f_{uk} = 700 \text{ N/mm}^2$; $f_{yk} = 450 \text{ N/mm}^2$; $A_5 > 12\%$ fracture elongation ¹⁾ M8 to M24
EN ISO 3506-1:2009			
2	Hexagon nut	Stainless steel A4 Property class 50 (for class 50 rod) Property class 70 (for class 70 rod; $\leq M24$)	EN ISO 3506-2:2009
3a	Washer	Stainless steel A4 (e.g.: EN ISO 7089:2000, EN ISO 7093:2000, EN ISO 7094:2000)	EN 10088-1: 2014
3b	Washer with bore	Material 1.4401 / 1.4404 / 1.4571 / 1.4362	
4	Internally threaded anchor rod	Material 1.4401 / 1.4404 / 1.4571 / 1.4362; $A_5 > 8 \%$ fracture elongation Property class 50 (IG-M20) Property class 70 (IG-M8 to IG-M16)	EN 10088-1: 2014
High corrosion resistant steel HCR			
1	Threaded rod	Material 1.4529 / 1.4565	EN 10088-1: 2014
		Property class 50	$f_{uk} = 500 \text{ N/mm}^2$; $f_{yk} = 210 \text{ N/mm}^2$; $A_5 > 12\%$ fracture elongation ¹⁾
		Property class 70	$f_{uk} = 700 \text{ N/mm}^2$; $f_{yk} = 450 \text{ N/mm}^2$; $A_5 > 12\%$ fracture elongation ¹⁾ M8 to M24
EN ISO 3506-1: 2009			
2	Hexagon nut	Material 1.4529 / 1.4565 Property class 50 ((for class 50 rod) Property class 70 (for class 70 rod; $\leq M24$)	EN 10088-1: 2014 EN ISO 3506-2:2009
3a	Washer	Material 1.4529 / 1.4565 (e.g.: EN ISO 7089:2000, EN ISO 7093:2000, EN ISO 7094:2000)	EN 10088-1: 2014
3b	Washer with bore	Material 1.4529 / 1.4565	
4	Internally threaded anchor rod	Material 1.4529 / 1.4565, $A_5 > 8 \%$ fracture elongation Property class 50 (IG-M20), Property class 70 (IG-M8 to IG-M16)	EN 10088-1: 2014

¹⁾ Fracture elongation $A_5 > 8 \%$ for applications without requirements for seismic performance category C2

Injection System VME for concrete

Product description
Materials

Annex A4

Reinforcing bar

Ø 8, Ø 10, Ø 12, Ø 14, Ø 16, Ø 20, Ø 25, Ø 28, Ø 32



- Minimum value of related rip area $f_{R,min}$ according to EN 1992-1-1:2004+AC:2010
- Rip height of the bar shall be in the range $0,05d \leq h \leq 0,07d$
(d: Nominal diameter of the bar; h: Rip height of the bar)

Table A2: Material reinforcing bar

Part	Designation	Material
Rebar		
5	Rebar EN 1992-1-1:2004+AC:2010, Annex C	Bars and de-coiled rods class B or C f_{yk} and k according to NDP or NCL of EN 1992-1-1/NA:2013 $f_{uk} = f_{tk} = k \cdot f_{yk}$

Injection System VME for concrete

Product description

Product description and material reinforcing bar

Annex A5

Specifications of intended use

Injection system VME	Anchor rod	Internally threaded anchor rod	rebar
	VMU-A, V-A, VM-A, commercial standard threaded rod	VMU-IG	
Static or quasi-static action	M8 - M30 (zinc plated, A4, HCR)	IG M6 - IG M20 (electroplated, A4, HCR)	Ø8 - Ø32
Seismic action Performance Category C1	M8 - M30 (zinc plated ¹⁾ , A4, HCR)	-	Ø8 - Ø32
Seismic action Performance Category C2	M12 and M16 (zinc plated ¹⁾ (class 8.8), A4, HCR)	-	-
Base material	Reinforced or unreinforced normal weight concrete acc. to EN 206-1:2000		
	Strength classes C20/25 to C50/60 acc. to EN 206-1:2000		
	Cracked and uncracked concrete		
Temperature Range I	-40 °C to +40 °C	max long term temperature +24 °C and max short term temperature +40 °C	
Temperature Range II	-40 °C to +60 °C	max long term temperature +43 °C and max short term temperature +60 °C	
Temperature Range III	-40 °C to +72 °C	max long term temperature +43 °C and max short term temperature +72 °C	

¹⁾ except hot-dip galvanised

Use conditions (Environmental conditions):

- Structures subject to dry internal conditions (zinc coated steel, stainless steel or high corrosion resistant steel)
- Structures subject to external atmospheric exposure (including industrial and marine environment) and to permanently damp internal condition, if no particular aggressive conditions exist (stainless steel or high corrosion resistant steel)
- Structures subject to external atmospheric exposure and to permanently damp internal condition, if other particular aggressive conditions exist (high corrosion resistant steel)

Note: Particular aggressive conditions are e.g. permanent, alternating immersion in seawater or the splash zone of seawater, chloride atmosphere of indoor swimming pools or atmosphere with extreme chemical pollution (e.g. in desulphurization plants or road tunnels where de-icing materials are used).

Design:

- Verifiable calculation notes and drawings are prepared taking account of the loads to be anchored. The position of the anchor is indicated on the design drawings (e.g. position of the anchor relative to reinforcement or to supports, etc.)
- Anchorages are designed under the responsibility of an engineer experienced in anchorages and concrete work
- Anchorages under static or quasi-static actions are designed in accordance with:
 - EOTA Technical Report TR 029 "Design of bonded anchors", Edition September 2010 or
 - CEN/TS 1992-4:2009
- Anchorages under seismic actions (cracked concrete) are designed in accordance with:
 - EOTA Technical Report TR 045 "Design of Metal Anchors under Seismic Action", Edition February 2013
 - Anchorages shall be positioned outside of critical regions (e.g. plastic hinges) of the concrete structure.
 - Fastenings in stand-off installation or with a grout layer are not allowed.

Installation:

- Dry or wet concrete, flooded holes (not sea water)
- Hole drilling by hammer or compressed air drill mode or vacuum drill mode
- Overhead installation allowed
- Anchor installation carried out by appropriately qualified personnel and under the supervision of the person responsible for technical matters of the site
- Fastening screws or threaded rods (incl. nut and washer) must comply with the appropriate material and property class of the internally threaded anchor rod

Injection System VME for concrete

Intended use
Specifications

Annex B1

Table B1: Installation parameters for threaded rod

Threaded rod		M8	M10	M12	M16	M20	M24	M27	M30
Nominal drill hole diameter	$d_0 =$ [mm]	10	12	14	18	24	28	32	35
Effective anchorage depth	$h_{ef,min} =$ [mm]	60	60	70	80	90	96	108	120
	$h_{ef,max} =$ [mm]	96	120	144	192	240	288	324	360
Diameter of clearance hole in the fixture ¹⁾	$d_f \leq$ [mm]	9	12	14	18	22	26	30	33
Installation torque	$T_{inst} \leq$ [Nm]	10	20	40	80	120	160	180	200
Minimum thickness of member	h_{min} [mm]	$h_{ef} + 30 \text{ mm}$ $\geq 100 \text{ mm}$			$h_{ef} + 2d_0$				
Minimum spacing	s_{min} [mm]	40	50	60	80	100	120	135	150
Minimum edge distance	c_{min} [mm]	40	50	60	80	100	120	135	150

¹⁾ For larger clearance hole see TR029 section 1.1; for application under seismic loading the diameter of clearance hole in the fixture shall be at maximum $d_{nom} + 1 \text{ mm}$ or alternatively the annular gap between fixture and threaded rod shall be completely filled with mortar

Table B2: Installation parameters for internally threaded anchor rod

Internally threaded anchor rod		IG-M 6	IG-M 8	IG-M 10	IG-M 12	IG-M 16	IG-M 20
Internal diameter of sleeve	$d_2 =$ [mm]	6	8	10	12	16	20
Outer diameter of sleeve ²⁾	$d_{nom} =$ [mm]	10	12	16	20	24	30
Nominal drill hole diameter	$d_0 =$ [mm]	12	14	18	24	28	35
Effective anchorage depth	$h_{ef,min} =$ [mm]	60	70	80	90	96	120
	$h_{ef,max} =$ [mm]	120	144	192	240	288	360
Diameter of clearance hole in the fixture ¹⁾	$d_f \leq$ [mm]	7	9	12	14	18	22
Installation torque	$T_{inst} \leq$ [Nm]	10	10	20	40	60	100
Minimum screw-in depth	l_{IG} [mm]	8	8	10	12	16	20
Minimum thickness of member	h_{min} [mm]	$h_{ef} + 30 \text{ mm}$ $\geq 100 \text{ mm}$			$h_{ef} + 2d_0$		
Minimum spacing	s_{min} [mm]	50	60	80	100	120	150
Minimum edge distance	c_{min} [mm]	50	60	80	100	120	150

¹⁾ For larger clearance hole see TR029 section 1.1

²⁾ With metric thread according to EN 1993-1-8:2005+AC:2009

Table B3: Installation parameters for rebar







Rebar		Ø 8	Ø 10	Ø 12	Ø 14	Ø 16	Ø 20	Ø 25	Ø 28	Ø 32
Nominal drill hole diameter	$d_0 =$ [mm]	12	14	16	18	20	24	32	35	40
Effective anchorage depth	$h_{ef,min} =$ [mm]	60	60	70	75	80	90	100	112	128
	$h_{ef,max} =$ [mm]	96	120	144	168	192	240	300	336	384
Minimum thickness of member	h_{min} [mm]	$h_{ef} + 30 \text{ mm}$ $\geq 100 \text{ mm}$			$h_{ef} + 2d_0$					
Minimum spacing	s_{min} [mm]	40	50	60	70	80	100	125	140	160
Minimum edge distance	c_{min} [mm]	40	50	60	70	80	100	125	140	160

Injection System VME for concrete

Intended use
Installation parameters

Annex B2

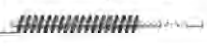
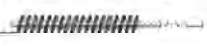
Table B4: Parameter cleaning and setting tools

Threaded rod 	Rebar 	Internally threaded anchor rod 	Drill bit 	Brush 	min. Brush 	Retaining washer 	Installation direction and use of retaining washer		
							[-]	↓	→
[-]	∅ [mm]	[-]	d ₀ [mm]	d _b [mm]	d _{b,min} [mm]	[-]			
M8			10	12	10,5	-	No retaining washer required		
M10	8	VMU-IG M6	12	14	12,5	-			
M12	10	VMU-IG M8	14	16	14,5	-			
	12		16	18	16,5	-	h _{ef} > 250mm		
M16	14	VMU-IG M10	18	20	18,5	VM-IA 18			
	16		20	22	20,5	VM-IA 20			
M 20	20	VMU-IG M12	24	26	24,5	VM-IA 24			
M 24		VMU-IG M16	28	30	28,5	VM-IA 28			
M 27	25		32	34	32,5	VM-IA 32			
M 30	28	VMU-IG M20	35	37	35,5	VM-IA 35			
	32		40	41,5	40,5	VM-IA 40		all	



Blow-out pump (volume 750ml)
Drill bit diameter (d₀): 10 mm to 20 mm
Bore hole depth h₀ ≤ 10 d_{nom}
see annex B4



Recommended compressed air tool (min 6 bar)
Drill bit diameter (d₀): all diameters



Retaining washer for overhead or horizontal installation
Drill bit diameter (d₀): 18 mm to 40 mm



Steel brush

Injection System VME for concrete

Intended use
Cleaning and setting tools

Annex B3

Installation instructions

Drilling of the hole

1.

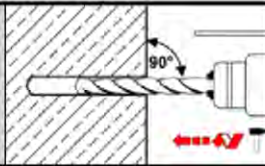

Drill a hole into the base material to the size and embedment depth required by the selected anchor (Annex B2). In case of aborted drill hole: the drill hole shall be filled with mortar.

Cleaning

Attention! Standing water in the bore hole must be removed before cleaning!

Cleaning with compressed air cracked and uncracked concrete, all diameters

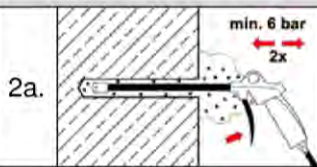

Starting from the bottom or back of the bore hole, blow the hole clean with compressed air (min. 6 bar) a minimum of **two** times. If the bore hole ground is not reached an extension shall be used.

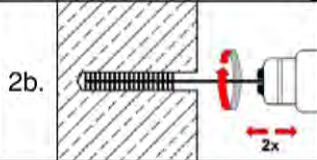

Attach the brush to a drilling machine or a battery screwdriver. Brush the hole with an appropriate sized wire brush $> d_{b,min}$ (Table B4) a minimum of **two** times. If the bore hole ground is not reached, a brush extension shall be used.

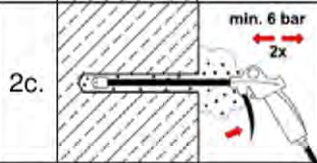

Finally blow the hole clean again with compressed air (min. 6 bar) a minimum of **two** times. If the bore hole ground is not reached an extension shall be used.

2.

Manual cleaning

uncracked concrete:
cracked concrete:

Bore hole diameter $d_0 \leq 20\text{mm}$ and bore hole depth $h_0 \leq 10 d_{nom}$

Bore hole diameter $14\text{mm} \leq d_0 \leq 20\text{mm}$ and bore hole depth $h_0 \leq 10 d_{nom}$

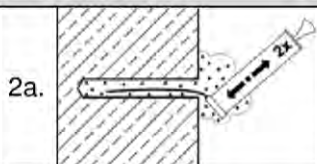

Starting from the bottom or back of the bore hole, blow the hole clean with the blow-out pump minimum of **two** times. If the bore hole ground is not reached an extension shall be used.

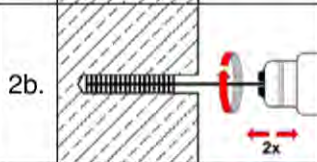

Attach the brush to a drilling machine or a battery screwdriver. Brush the hole with an appropriate sized wire brush $> d_{b,min}$ (Table B4) a minimum of **two** times. If the bore hole ground is not reached, a brush extension shall be used

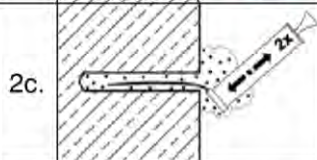

Finally blow the hole clean again with the blow-out pump a minimum of **two** times. If the bore hole ground is not reached an extension shall be used.

After cleaning, the bore hole has to be protected against re-contamination in an appropriate way, until dispensing the mortar in the bore hole. If necessary, the cleaning repeated has to be directly before dispensing the mortar. In-flowing water must not contaminate the bore hole again.





Injection System VME for concrete

Intended use

Installation instruction

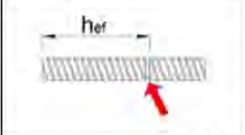
Annex B4

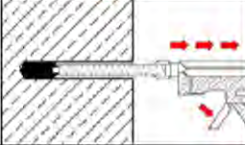
Installation instructions (continuation)

Injection		
3.		Attach a supplied static-mixing nozzle to the cartridge and load the cartridge into the correct dispensing tool. For every working interruption longer than the recommended working time (Table B5) as well as for new cartridges, a new static-mixer shall be used.
4.		Prior to inserting the anchor rod into the filled bore hole, the position of the embedment depth shall be marked on the anchor rod or rebar.
5.		Prior to dispensing into the anchor hole, squeeze out separately a minimum of three full strokes and discard non-uniformly mixed adhesive components until the mortar shows a consistent grey or red colour.
6a.		Starting from the bottom or back of the cleaned anchor hole, fill the hole up to approximately two-thirds with adhesive. Slowly withdraw the static mixing nozzle as the hole fills to avoid creating air pockets. For embedment larger than 190 mm an extension nozzle shall be used. Observe the curing and working times given in Table B5.
6b.		For overhead and horizontal installation a retaining washer (Annex B 3) and extension nozzle shall be used. Observe the curing and working times given in Table B5.

Injection System VME for concrete

Intended use
Installation instructions (continuation)

Annex B5

Installation instructions (continuation)



Inserting the anchor		
7.		Push the threaded rod or reinforcing bar into the anchor hole while turning slightly to ensure positive distribution of the adhesive until the embedment depth is reached. The anchor shall be free of dirt, grease, oil or other foreign material.
8.		Be sure that the rod is fully seated at the bottom of the hole and that excess mortar is visible at the top of the hole. If these requirements are not maintained, the application has to be renewed. For overhead application the anchor rod should be fixed (e.g. wedges).
9.		Allow the adhesive to cure to the specified time prior to applying any load or torque. Do not move or load the rod until it is fully cured (attend Table B5).
10.		Remove excess mortar.
11.		After full curing, the add-on part can be installed with up to the max. torque (Table B1 or B2) by using a calibrated torque wrench.
12.		Annular gap between anchor rod and attachment may optionally be filled with mortar. Therefore replace regular washer by washer with bore and plug on reducing adapter on static mixer. Annular gap is completely filled, when excess mortar seeps out.

Table B5: Working and curing time

Bore hole temperature	Maximum working time	Minimum curing time	
		dry concrete	wet concrete
+5°C to +9°C	120 min	50 h	100 h
+10°C to +19°C	90 min	30 h	60 h
+20°C to +29°C	30 min	10 h	20 h
+30°C to +39°C	20 min	6 h	12 h
+40°C	12 min	4 h	8 h
Cartridge temperature	+ 5°C to + 40°C		

Injection System VME for concrete

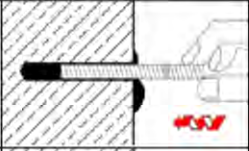
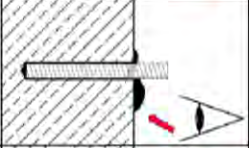
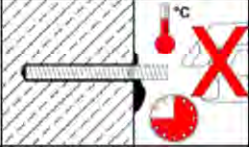
Intended use
Installation instructions (continuation), Working and curing time

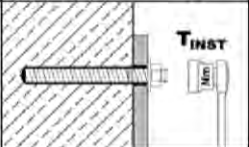
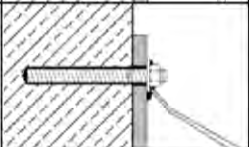
Annex B6

Table C1: Characteristic steel resistances for threaded rods under tension and shear load

Threaded rod				M 8	M 10	M 12	M 16	M 20	M24	M 27	M 30
Steel failure											
Tension load											
Characteristic tension resistance	Steel, Property class 4.6 and 4.8	$N_{Rk,s}$	[kN]	15	23	34	63	98	141	184	224
	Steel, Property class 5.6 and 5.8	$N_{Rk,s}$	[kN]	18	29	42	78	122	176	230	280
	Steel, Property class 8.8	$N_{Rk,s}$	[kN]	29	46	67	125	196	282	368	449
	Stainless steel A4 and HCR, Property class 50	$N_{Rk,s}$	[kN]	18	29	42	79	123	177	230	281
	Stainless steel A4 and HCR, Property class 70	$N_{Rk,s}$	[kN]	26	41	59	110	171	247	-	-
Partial factor	Steel, Property class 4.6	$\gamma_{Ms,N}$	[-]	2,0							
	Steel, Property class 4.8	$\gamma_{Ms,N}$	[-]	1,5							
	Steel, Property class 5.6	$\gamma_{Ms,N}$	[-]	2,0							
	Steel, Property class 5.8 and 8.8	$\gamma_{Ms,N}$	[-]	1,5							
	Stainless steel A4 and HCR, Property class 50	$\gamma_{Ms,N}$	[-]	2,86							
	Stainless steel A4 and HCR, Property class 70	$\gamma_{Ms,N}$	[-]	1,87							-
Shear load											
Steel failure without lever arm											
Characteristic shear resistance	Steel, Property class 4.6 and 4.8	$V_{Rk,s}$	[kN]	7	12	17	31	49	71	92	112
	Steel, Property class 5.6 and 5.8	$V_{Rk,s}$	[kN]	9	15	21	39	61	88	115	140
	Steel, Property class 8.8	$V_{Rk,s}$	[kN]	15	23	34	63	98	141	184	224
	Stainless steel A4 and HCR, Property class 50	$V_{Rk,s}$	[kN]	9	15	21	39	61	88	115	140
	Stainless steel A4 and HCR, Property class 70	$V_{Rk,s}$	[kN]	13	20	30	55	86	124	-	-
Steel failure with lever arm											
Characteristic bending moment	Steel, Property class 4.6 and 4.8	$M_{Rk,s}$	[Nm]	15	30	52	133	260	449	666	900
	Steel, Property class 5.6 and 5.8	$M_{Rk,s}$	[Nm]	19	37	65	166	324	560	833	1123
	Steel, Property class 8.8	$M_{Rk,s}$	[Nm]	30	60	105	266	519	896	1333	1797
	Stainless steel A4 and HCR, Property class 50	$M_{Rk,s}$	[Nm]	19	37	66	167	325	561	832	1125
	Stainless steel A4 and HCR, Property class 70	$M_{Rk,s}$	[Nm]	26	52	92	232	454	784	-	-
Partial factor	Steel, Property class 4.6	$\gamma_{Ms,V}$	[-]	1,67							
	Steel, Property class 4.8	$\gamma_{Ms,V}$	[-]	1,25							
	Steel, Property class 5.6	$\gamma_{Ms,V}$	[-]	1,67							
	Steel, Property class 5.8 and 8.8	$\gamma_{Ms,V}$	[-]	1,25							
	Stainless steel A4 and HCR, Property class 50	$\gamma_{Ms,V}$	[-]	2,38							
	Stainless steel A4 and HCR, Property class 70	$\gamma_{Ms,V}$	[-]	1,56							-

Injection System VME for concrete

Performance

Characteristic **steel resistances** for **threaded rods** under tension and shear loads

Annex C1

English translation prepared by DIBt

Table C2: Characteristic values of **tension loads** for **threaded rods** under static, quasi-static action and seismic action C1 + C2

Threaded rod		M8	M10	M12	M16	M20	M24	M27	M30	
Steel failure										
Characteristic tension resistance	$N_{Rk,s}$	[kN]	see Table C1							
	$N_{Rk,s,C1}$	[kN]	$1,0 \cdot N_{Rk,s}$							
	$N_{Rk,s,C2}$	[kN]	NPD	$1,0 \cdot N_{Rk,s}$		No Performance Determined (NPD)				
Partial factor	$\gamma_{Ms,N}$	[-]	see Table C1							
Combined pull-out and concrete failure										
Characteristic bond resistance in uncracked concrete C20/25										
Temperature range I: 40°C / 24°C	dry and wet concrete	$\tau_{Rk,ucr}$	[N/mm ²]	15	15	15	14	13	12	12
	flooded bore hole	$\tau_{Rk,ucr}$	[N/mm ²]	15	14	13	10	9,5	8,5	7,5
Temperature range II: 60°C / 43°C	dry and wet concrete	$\tau_{Rk,ucr}$	[N/mm ²]	9,5	9,5	9,0	8,5	8,0	7,5	7,5
	flooded bore hole	$\tau_{Rk,ucr}$	[N/mm ²]	9,5	9,5	9,0	8,5	7,5	7,0	6,5
Temperature range III: 72°C / 43°C	dry and wet concrete	$\tau_{Rk,ucr}$	[N/mm ²]	8,5	8,5	8,0	7,5	7,0	7,0	6,5
	flooded bore hole	$\tau_{Rk,ucr}$	[N/mm ²]	8,5	8,5	8,0	7,5	7,0	6,0	5,5
Characteristic bond resistance in cracked concrete C20/25										
Temperature range I: 40°C / 24°C	dry and wet concrete	$\tau_{Rk,cr}$	[N/mm ²]	7,0	7,0	7,5	6,5	6,0	5,5	5,5
		$\tau_{Rk,C1}$	[N/mm ²]	5,9	7,0	7,1	6,2	5,7	5,5	5,5
		$\tau_{Rk,C2}$	[N/mm ²]	NPD		2,4	2,2	No Performance Determined (NPD)		
	flooded bore hole	$\tau_{Rk,cr}$	[N/mm ²]	7,0	7,0	7,5	6,0	5,0	4,5	4,0
		$\tau_{Rk,C1}$	[N/mm ²]	5,9	7,0	7,1	5,8	4,8	4,5	4,0
		$\tau_{Rk,C2}$	[N/mm ²]	NPD		2,4	2,1	No Performance Determined (NPD)		
Temperature range II: 60°C / 43°C	dry and wet concrete	$\tau_{Rk,cr}$	[N/mm ²]	4,5	4,5	4,5	4,0	3,5	3,5	3,5
		$\tau_{Rk,C1}$	[N/mm ²]	3,7	4,5	4,3	3,8	3,4	3,5	3,5
		$\tau_{Rk,C2}$	[N/mm ²]	NPD		1,4	1,4	No Performance Determined (NPD)		
	flooded bore hole	$\tau_{Rk,cr}$	[N/mm ²]	4,5	4,5	4,5	4,0	3,5	3,5	3,5
		$\tau_{Rk,C1}$	[N/mm ²]	3,7	4,5	4,3	3,8	3,4	3,5	3,5
		$\tau_{Rk,C2}$	[N/mm ²]	NPD		1,4	1,4	No Performance Determined (NPD)		
Temperature range III: 72°C / 43°C	dry and wet concrete	$\tau_{Rk,cr}$	[N/mm ²]	4,0	4,0	4,0	3,5	3,0	3,0	3,0
		$\tau_{Rk,C1}$	[N/mm ²]	3,2	4,0	3,9	3,4	3,0	3,0	3,0
		$\tau_{Rk,C2}$	[N/mm ²]	NPD		1,3	1,2	No Performance Determined (NPD)		
	flooded bore hole	$\tau_{Rk,cr}$	[N/mm ²]	4,0	4,0	4,0	3,5	3,0	3,0	3,0
		$\tau_{Rk,C1}$	[N/mm ²]	3,2	4,0	3,9	3,4	3,0	3,0	3,0
		$\tau_{Rk,C2}$	[N/mm ²]	NPD		1,3	1,2	No Performance Determined (NPD)		
Increasing factor for concrete	ψ_c	C25/30		1,02						
		C30/37		1,04						
		C35/45		1,07						
		C40/50		1,08						
		C45/55		1,09						
		C50/60		1,10						
Factor acc. CEN/TS1992-4-5 section 6.2.2.3	uncracked concrete	k_B	[-]	10,1						
	cracked concrete			7,2						
Concrete cone failure										
Factor acc. CEN/TS1992-4-5 section 6.2.3.1	uncracked concrete	k_{ucr}	[-]	10,1						
	cracked concrete	k_{cr}	[-]	7,2						
Edge distance	$c_{cr,N}$	[-]	1,5 h_{ef}							
Spacing	$s_{cr,N}$	[-]	3,0 h_{ef}							
Splitting failure										
Edge distance	$h/h_{ef} \geq 2,0$	$c_{cr,sp}$	[mm]	1,0 h_{ef}						
	$2,0 > h/h_{ef} > 1,3$			$2 \cdot h_{ef} (2,5 - h/h_{ef})$						
	$h/h_{ef} \leq 1,3$			2,4 h_{ef}						
Spacing	$s_{cr,sp}$	[-]	[-]	2 $c_{cr,sp}$						
Installation factor (dry and wet concrete)	$\gamma_2 = \gamma_{inst}$	[-]		1,2			1,4			
Installation factor (flooded bore hole)	$\gamma_2 = \gamma_{inst}$	[-]		1,4						

Injection System VME for concrete

Performance
Characteristic values of **tension loads** for **threaded rods** under static, quasi-static action and seismic action C1 + C2

Annex C2

Table C3: Characteristic values of **shear loads** for **threaded rods**
under static, quasi-static action and seismic action C1 + C2

Threaded rod		M8	M10	M12	M16	M20	M24	M27	M30	
Steel failure <u>without</u> lever arm										
Characteristic shear resistance	$V_{Rk,s}$ [kN]	see Table C1								
	$V_{Rk,s,C1}$ [kN]	$0,86 \cdot V_{Rk,s}$			$0,88 \cdot V_{Rk,s}$			$0,80 \cdot V_{Rk,s}$		
	$V_{Rk,s,C2}$ [kN]	NPD		$0,80 \cdot V_{Rk,s}$		No Performance Determined (NPD)				
Partial factor	$\gamma_{Ms,V}$ [-]	see Table C1								
Steel failure <u>with</u> lever arm										
Characteristic bending moment	$M^0_{Rk,s}$ [Nm]	see Table C1								
	$M^0_{Rk,s,C1}$ [Nm]	No Performance Determined (NPD)								
	$M^0_{Rk,s,C2}$ [Nm]									
Partial factor	$\gamma_{Ms,V}$ [-]	see Table C1								
Concrete pry-out failure										
Factor k in equation (5.7) acc. to Technical Report TR 029 Factor k_3 in equation (27) acc. to CEN/TS 1992-4-5 section 6.3.3	$k_{(3)}$ [-]	2,0								
Concrete edge failure										
Effective length of anchor	l_f [mm]	$l_f = \min(h_{ef}; 8 d_{nom})$								
Outside diameter of anchor	d_{nom} [mm]	8	10	12	16	20	24	27	30	
Installation factor	$\gamma_2 = \gamma_{inst}$ [-]	1,0								

Injection System VME for concrete

Performance
Characteristic values of **shear loads** for **threaded rods**
under static, quasi-static action and seismic action C1 + C2

Annex C3

Table C4: Characteristic values of tension loads for internally threaded anchor rods under static and quasi-static action

Internally threaded anchor rod			IG-M 6	IG-M 8	IG-M 10	IG-M 12	IG-M 16	IG-M 20	
Steel failure¹⁾									
Characteristic tension resistance, Steel, strength class 5.8	$N_{Rk,s}$	[kN]	10	18	29	42	79	123	
Partial factor	$\gamma_{Ms,N}$	[-]	1,5						
Characteristic tension resistance, Steel, strength class 8.8	$N_{Rk,s}$	[kN]	16	27	46	67	121	196	
Partial factor	$\gamma_{Ms,N}$	[-]	1,5						
Characteristic tension resistance, Stainless steel A4 / HCR, strength class 70	$N_{Rk,s}$	[kN]	14	26	41	59	110	124 ²⁾	
Partial factor	$\gamma_{Ms,N}$	[-]	1,87						
Combined pull-out and concrete failure									
Characteristic bond resistance in <u>uncracked</u> concrete C20/25									
Temperature range I: 40°C / 24°C	dry and wet concrete	$\tau_{Rk,ucr}$	[N/mm ²]	15	15	14	13	12	12
	flooded bore hole	$\tau_{Rk,ucr}$	[N/mm ²]	14	13	10	9,5	8,5	7,0
Temperature range II: 60°C / 43°C	dry and wet concrete	$\tau_{Rk,ucr}$	[N/mm ²]	9,5	9,0	8,5	8,0	7,5	7,5
	flooded bore hole	$\tau_{Rk,ucr}$	[N/mm ²]	9,5	9,0	8,5	7,5	7,0	6,0
Temperature range III: 72°C / 43°C	dry and wet concrete	$\tau_{Rk,ucr}$	[N/mm ²]	8,5	8,0	7,5	7,0	7,0	6,5
	flooded bore hole	$\tau_{Rk,ucr}$	[N/mm ²]	8,5	8,0	7,5	7,0	6,0	5,5
Characteristic bond resistance in <u>cracked</u> concrete C20/25									
Temperature range I: 40°C / 24°C	dry and wet concrete	$\tau_{Rk,cr}$	[N/mm ²]	7,0	7,5	6,5	6,0	5,5	5,5
	flooded bore hole	$\tau_{Rk,cr}$	[N/mm ²]	7,0	7,5	6,0	5,0	4,5	4,0
Temperature range II: 60°C / 43°C	dry and wet concrete	$\tau_{Rk,cr}$	[N/mm ²]	4,5	4,5	4,0	3,5	3,5	3,5
	flooded bore hole	$\tau_{Rk,cr}$	[N/mm ²]	4,5	4,5	4,0	3,5	3,5	3,5
Temperature range III: 72°C / 43°C	dry and wet concrete	$\tau_{Rk,cr}$	[N/mm ²]	4,0	4,0	3,5	3,0	3,0	3,0
	flooded bore hole	$\tau_{Rk,cr}$	[N/mm ²]	4,0	4,0	3,5	3,0	3,0	3,0
Increasing factor for concrete		ψ_c		C25/30	1,02				
				C30/37	1,04				
				C35/45	1,07				
				C40/50	1,08				
				C45/55	1,09				
				C50/60	1,10				
Factor acc. to CEN/TS1992-4-5 section 6.2.2.3	uncracked concrete	k_B	[-]	10,1					
	cracked concrete			7,2					
Concrete cone failure									
Factor acc. to CEN/TS1992-4-5 section 6.2.3.1	uncracked concrete	k_{ucr}	[-]	10,1					
	cracked concrete	k_{cr}	[-]	7,2					
Edge distance		$c_{cr,N}$	[mm]	1,5 h_{ef}					
Spacing		$s_{cr,N}$	[mm]	3,0 h_{ef}					
Splitting failure									
Edge distance	$h/h_{ef} \geq 2,0$	$c_{cr,sp}$	[mm]	1,0 h_{ef}					
	$2,0 > h/h_{ef} > 1,3$			$2 \cdot h_{ef} (2,5 - h/h_{ef})$					
	$h/h_{ef} \leq 1,3$			2,4 h_{ef}					
Spacing		$s_{cr,sp}$	[mm]	$2 c_{cr,sp}$					
Installation factor (dry and wet concrete)	$\gamma_2 = \gamma_{inst}$	[-]		1,2			1,4		
Installation factor (flooded bore hole)	$\gamma_2 = \gamma_{inst}$	[-]		1,4					

¹⁾ Fastening screws or threaded rods (incl. nut and washer) must comply with the appropriate material and property class of the internally threaded anchor rod. The characteristic tension resistance for steel failure of the given strength class are valid for the internally threaded anchor rod and the fastening element

²⁾ For VMU-IG M20: Internally threaded rod: strength class 50; Fastening screws or threaded rods (incl. nut and washer): strength class 70

Injection System VME for concrete

Performance

Characteristic values of **tension loads** for internally threaded anchor rods under static and quasi-static action

Annex C4

Table C5: Characteristic values of shear loads for internally threaded anchor rods under static and quasi-static action

Internally threaded anchor rod			IG-M 6	IG-M 8	IG-M 10	IG-M 12	IG-M 16	IG-M 20
Steel failure without lever arm¹⁾								
Characteristic shear resistance Steel, strength class 5.8	$V_{Rk,s}$	[kN]	5	9	15	21	39	61
Partial factor	$\gamma_{Ms,v}$	[-]	1,25					
Characteristic shear resistance Steel, strength class 8.8	$V_{Rk,s}$	[kN]	8	14	23	34	60	98
Partial factor	$\gamma_{Ms,v}$	[-]	1,25					
Characteristic shear resistance Stainless steel A4 / HCR strength class 70	$V_{Rk,s}$	[kN]	7	13	20	30	55	62 ²⁾
Partial factor	$\gamma_{Ms,v}$	[-]	1,56					
Steel failure with lever arm¹⁾								
Characteristic bending moment, Steel, strength class 5.8	$M^0_{Rk,s}$	[Nm]	8	19	37	66	167	325
Partial factor	$\gamma_{Ms,v}$	[-]	1,25					
Characteristic bending moment, Steel, strength class 8.8	$M^0_{Rk,s}$	[Nm]	12	30	60	105	267	519
Partial factor	$\gamma_{Ms,v}$	[-]	1,25					
Characteristic bending moment, Stainless steel A4 / HCR strength class 70	$M^0_{Rk,s}$	[Nm]	11	26	53	92	234	643 ²⁾
Partial factor	$\gamma_{Ms,v}$	[-]	1,56					
Concrete pry-out failure								
Factor k in equation (5.7) of Technical Report TR 029 Factor k_3 in equation (27) of CEN/TS 1992-4-5 section 6.3.3	$k_{(3)}$	[-]	2,0					
Concrete edge failure								
Effective length of anchor	l_f	[mm]	$l_f = \min(h_{ef}; 8 d_{nom})$					
Outside diameter of anchor	d_{nom}	[mm]	10	12	16	20	24	30
Installation factor	$\gamma_2 = \gamma_{inst}$	[-]	1,0					

¹⁾ Fastening screws or threaded rods (incl. nut and washer) must comply with the appropriate material and property class of the internally threaded anchor rod. The characteristic shear resistance for steel failure of the given strength class are valid for the internally threaded anchor rod and the fastening element

²⁾ For VMU-IG M20: Internally threaded rod: strength class 50; Fastening screws or threaded rods (incl. nut and washer): strength class 70

Injection System VME for concrete

Performance

Characteristic values of **shear loads** for internally threaded anchor rods under static and quasi-static action

Annex C5

Table C6: Characteristic values of **tension loads** for **rebar** under static, quasi-static action and seismic action C1

Reinforcing bar			Ø 8	Ø 10	Ø 12	Ø 14	Ø 16	Ø 20	Ø 25	Ø 28	Ø 32	
Steel failure												
Characteristic tension resistance	$N_{Rk,s}$	[kN]	$A_s \cdot f_{uk}^{1)}$									
	$N_{Rk,s,C1}$	[kN]	$1,0 \cdot N_{Rk,s}$									
Cross section area	A_s	[mm ²]	50	79	113	154	201	314	491	616	804	
Partial factor	$\gamma_{Ms,N}$	[-]	$1,4^{2)}$									
Combined pull-out and concrete failure												
Characteristic bond resistance in <u>uncracked</u> concrete C20/25												
Temperature range I: 40°C / 24°C	dry and wet concrete	$\tau_{Rk,ucr}$	[N/mm ²]	14	14	13	13	12	12	11	11	11
	flooded bore hole	$\tau_{Rk,ucr}$	[N/mm ²]	14	13	11	10	9,5	8,5	7,5	7,0	6,0
Temperature range II: 60°C / 43°C	dry and wet concrete	$\tau_{Rk,ucr}$	[N/mm ²]	8,5	8,5	8,0	8,0	7,5	7,0	7,0	6,5	6,5
	flooded bore hole	$\tau_{Rk,ucr}$	[N/mm ²]	8,5	8,5	8,0	8,0	7,5	7,0	6,0	5,5	5,0
Temperature range III: 72°C / 43°C	dry and wet concrete	$\tau_{Rk,ucr}$	[N/mm ²]	7,5	7,5	7,5	7,0	7,0	6,5	6,0	6,0	6,0
	flooded bore hole	$\tau_{Rk,ucr}$	[N/mm ²]	7,5	7,5	7,5	7,0	7,0	6,0	5,5	5,0	4,5
Characteristic bond resistance in <u>cracked</u> concrete C20/25												
Temperature range I: 40°C / 24°C	dry and wet concrete	$\tau_{Rk,cr}$	[N/mm ²]	7,0	7,0	7,5	7,0	6,5	6,0	5,5	5,5	5,5
		$\tau_{Rk,C1}$	[N/mm ²]	5,9	7,0	7,1	6,4	6,2	5,7	5,5	5,5	5,5
	flooded bore hole	$\tau_{Rk,cr}$	[N/mm ²]	7,0	7,0	7,5	6,5	6,0	5,0	4,5	4,0	4,0
		$\tau_{Rk,C1}$	[N/mm ²]	5,9	7,0	7,1	6,0	5,7	4,8	4,5	4,0	4,0
Temperature range II: 60°C / 43°C	dry and wet concrete	$\tau_{Rk,cr}$	[N/mm ²]	4,5	4,5	4,5	4,0	4,0	3,5	3,5	3,5	3,5
		$\tau_{Rk,C1}$	[N/mm ²]	3,7	4,5	4,3	3,7	3,8	3,3	3,5	3,5	3,5
	flooded bore hole	$\tau_{Rk,cr}$	[N/mm ²]	4,5	4,5	4,5	4,0	4,0	3,5	3,5	3,5	3,0
		$\tau_{Rk,C1}$	[N/mm ²]	3,7	4,5	4,3	3,7	3,8	3,3	3,5	3,5	3,0
Temperature range III: 72°C / 43°C	dry and wet concrete	$\tau_{Rk,cr}$	[N/mm ²]	4,0	4,0	4,0	3,5	3,5	3,0	3,0	3,0	3,0
		$\tau_{Rk,C1}$	[N/mm ²]	3,2	4,0	3,9	3,2	3,3	2,9	3,0	3,0	3,0
	flooded bore hole	$\tau_{Rk,cr}$	[N/mm ²]	4,0	4,0	4,0	3,5	3,5	3,0	3,0	3,0	3,0
		$\tau_{Rk,C1}$	[N/mm ²]	3,2	4,0	3,9	3,2	3,3	2,9	3,0	3,0	3,0
Increasing factor for concrete		ψ_c	C25/30	1,02								
			C30/37	1,04								
			C35/45	1,07								
			C40/50	1,08								
			C45/55	1,09								
			C50/60	1,10								
Factor acc. CEN/TS1992-4-5 section 6.2.2.3	uncracked concrete	k_B	[-]	10,1								
	cracked concrete		[-]	7,2								
Concrete cone failure												
Factor acc. CEN/TS1992-4-5 section 6.2.3.1	uncracked concrete	k_{ucr}	[-]	10,1								
	cracked concrete	k_{cr}	[-]	7,2								
Edge distance		$c_{cr,N}$	[mm]	$1,5 h_{ef}$								
Spacing		$s_{cr,N}$	[mm]	$3,0 h_{ef}$								
Splitting failure												
Edge distance	$h/h_{ef} \geq 2,0$	$c_{cr,sp}$	[mm]	$1,0 h_{ef}$								
	$2,0 > h/h_{ef} > 1,3$			$2 \cdot h_{ef} (2,5 - h/h_{ef})$								
	$h/h_{ef} \leq 1,3$			$2,4 h_{ef}$								
Spacing		$s_{cr,sp}$	[mm]	$2 c_{cr,sp}$								
Installation factor (dry and wet concrete)		$\gamma_2 = \gamma_{inst}$	[-]	1,2				1,4				
Installation factor (flooded bore hole)		$\gamma_2 = \gamma_{inst}$	[-]	1,4								

¹⁾ f_{uk} shall be taken from the specifications of reinforcing bar

²⁾ in absence of national regulation

Injection System VME for concrete

Performance
Characteristic values of **tension loads** for **rebar**
under static, quasi-static action and seismic action C1

Annex C6

Table C7: Characteristic values of **shear loads** for rebar
under static, quasi-static action and seismic action C1

Reinforcing bar		Ø 8	Ø 10	Ø 12	Ø 14	Ø 16	Ø 20	Ø 25	Ø 28	Ø 32	
Steel failure <u>without</u> lever arm											
Characteristic shear resistance	$V_{Rk,s}$	[kN]	$0,50 \cdot A_s \cdot f_{uk}^{1)}$								
	$V_{Rk,s,C1}$	[kN]	$0,80 \cdot V_{Rk,s}$		$0,88 \cdot V_{Rk,s}$						
Cross section area	A_s	[mm ²]	50	79	113	154	201	314	491	804	
Partial factor	$\gamma_{Ms,v}$	[-]	$1,5^{2)}$								
Steel failure <u>with</u> lever arm											
Characteristic bending moment	$M_{Rk,s}^0$	[Nm]	$1,2 \cdot W_{el} \cdot f_{uk}^{1)}$								
	$M_{Rk,s,C1}^0$	[Nm]	No Performance Determined (NPD)								
Elastic section modulus	W_{el}	[mm ³]	50	98	170	269	402	785	1534	3217	
Partial factor	$\gamma_{Ms,v}$	[-]	$1,5^{2)}$								
Concrete pry-out failure											
Factor k in equation (5.7) of Technical Report TR 029 Factor k_3 in equation (27) of CEN/TS 1992-4-5 section 6.3.3	$k_{(3)}$	[-]	2,0								
Concrete edge failure											
Effective length of anchor	l_f	[mm]	$l_f = \min(h_{ef}; 8 d_{nom})$								
Outside diameter of rebar	d_{nom}	[mm]	8	10	12	14	16	20	25	28	32
Installation factor	$\gamma_2 = \gamma_{inst}$	[-]	1,0								

¹⁾ f_{uk} shall be taken from the specifications of reinforcing bars

²⁾ in absence of national regulation

Injection System VME for concrete

Performance

Characteristic values of **shear loads** for rebar
under static, quasi-static action and seismic action C1

Annex C7

Table C8: Displacements under tension load¹⁾ (threaded rod)

Threaded rod			M8	M10	M12	M16	M20	M24	M27	M30
Uncracked concrete C20/25 under static and quasi-static action										
Temperature range I: 40°C / 24°C	δ_{N0} - factor	[mm/(N/mm ²)]	0,011	0,013	0,015	0,020	0,024	0,029	0,032	0,035
	$\delta_{N\infty}$ - factor	[mm/(N/mm ²)]	0,044	0,052	0,061	0,079	0,096	0,114	0,127	0,140
Temperature range II: 60°C / 43°C	δ_{N0} - factor	[mm/(N/mm ²)]	0,013	0,015	0,018	0,023	0,028	0,033	0,037	0,043
	$\delta_{N\infty}$ - factor	[mm/(N/mm ²)]	0,050	0,060	0,070	0,091	0,111	0,131	0,146	0,161
Temperature range III: 72°C / 43°C	δ_{N0} - factor	[mm/(N/mm ²)]	0,013	0,015	0,018	0,023	0,028	0,033	0,037	0,043
	$\delta_{N\infty}$ - factor	[mm/(N/mm ²)]	0,050	0,060	0,070	0,091	0,111	0,131	0,146	0,161
Cracked concrete C20/25 under static and quasi-static action										
Temperature range I: 40°C / 24°C	δ_{N0} - factor	[mm/(N/mm ²)]	0,032	0,032	0,032	0,037	0,042	0,048	0,053	0,058
	$\delta_{N\infty}$ - factor	[mm/(N/mm ²)]	0,210	0,210	0,210	0,210	0,210	0,210	0,210	0,210
Temperature range II: 60°C / 43°C	δ_{N0} - factor	[mm/(N/mm ²)]	0,032	0,032	0,037	0,043	0,049	0,055	0,061	0,067
	$\delta_{N\infty}$ - factor	[mm/(N/mm ²)]	0,240	0,240	0,240	0,240	0,240	0,240	0,240	0,240
Temperature range III: 72°C / 43°C	δ_{N0} - factor	[mm/(N/mm ²)]	0,032	0,032	0,037	0,043	0,049	0,055	0,061	0,067
	$\delta_{N\infty}$ - factor	[mm/(N/mm ²)]	0,240	0,240	0,240	0,240	0,240	0,240	0,240	0,240
Cracked concrete C20/25 under seismic action (C2)										
All temperature ranges	$\delta_{N,seis}$ (DLS) - factor	[mm/(N/mm ²)]	NPD		0,03	0,05	No Performance Determined (NPD)			
	$\delta_{N,seis}$ (ULS) - factor	[mm/(N/mm ²)]			0,06	0,09				

¹⁾ Calculation of the displacement

$$\delta_{N0} = \delta_{N0}\text{- factor} \cdot \tau; \quad \delta_{N,seis}(DLS) = \delta_{N,seis}(DLS)\text{- factor} \cdot \tau; \quad \tau: \text{action bond stress for tension}$$

$$\delta_{N\infty} = \delta_{N\infty}\text{- factor} \cdot \tau; \quad \delta_{N,seis}(ULS) = \delta_{N,seis}(ULS)\text{- factor} \cdot \tau;$$

Table C9: Displacements under shear load¹⁾ (threaded rod)

Threaded rod			M 8	M 10	M 12	M 16	M 20	M 24	M 27	M 30
Uncracked and cracked concrete C20/25 under static and quasi-static action										
All temperature ranges	δ_{V0} - factor	[mm/(kN)]	0,06	0,06	0,05	0,04	0,04	0,03	0,03	0,03
	$\delta_{V\infty}$ - factor	[mm/(kN)]	0,09	0,08	0,08	0,06	0,06	0,05	0,05	0,05
Cracked concrete C20/25 under seismic action (C2)										
All temperature ranges	$\delta_{V,seis}(DLS)$ - factor	[mm/(kN)]	NPD		0,2	0,1	No Performance Determined (NPD)			
	$\delta_{V,seis}(ULS)$ - factor	[mm/(kN)]			0,2	0,1				

¹⁾ Calculation of the displacement

$$\delta_{V0} = \delta_{V0}\text{- factor} \cdot V; \quad \delta_{V,seis}(DLS) = \delta_{V,seis}(DLS)\text{- factor} \cdot V; \quad V: \text{action shear load}$$

$$\delta_{V\infty} = \delta_{V\infty}\text{- factor} \cdot V; \quad \delta_{V,seis}(ULS) = \delta_{V,seis}(ULS)\text{- factor} \cdot V;$$

Injection System VME for concrete

Performance
Displacements (threaded rod)

Annex C8

Table C10: Displacements under tension load¹⁾ (internally threaded anchor rod)

Internally threaded anchor rod			IG-M6	IG-M8	IG-M10	IG-M12	IG-M16	IG-M20
Uncracked concrete C20/25 under static and quasi-static action								
Temperature range I: 40°C / 24°C	δ_{N0} -factor	[mm/(N/mm ²)]	0,013	0,015	0,020	0,024	0,029	0,035
	$\delta_{N\infty}$ - factor	[mm/(N/mm ²)]	0,052	0,061	0,079	0,096	0,114	0,140
Temperature range II: 60°C / 43°C	δ_{N0} - factor	[mm/(N/mm ²)]	0,015	0,018	0,023	0,028	0,033	0,043
	$\delta_{N\infty}$ - factor	[mm/(N/mm ²)]	0,060	0,070	0,091	0,111	0,131	0,161
Temperature range III: 72°C / 43°C	δ_{N0} - factor	[mm/(N/mm ²)]	0,015	0,018	0,023	0,028	0,033	0,043
	$\delta_{N\infty}$ - factor	[mm/(N/mm ²)]	0,060	0,070	0,091	0,111	0,131	0,161
Cracked concrete C20/25 under static and quasi-static action								
Temperature range I: 40°C / 24°C	δ_{N0} - factor	[mm/(N/mm ²)]	0,032	0,032	0,037	0,042	0,048	0,058
	$\delta_{N\infty}$ - factor	[mm/(N/mm ²)]	0,210	0,210	0,210	0,210	0,210	0,210
Temperature range II: 60°C / 43°C	δ_{N0} - factor	[mm/(N/mm ²)]	0,032	0,037	0,043	0,049	0,055	0,067
	$\delta_{N\infty}$ - factor	[mm/(N/mm ²)]	0,240	0,240	0,240	0,240	0,240	0,240
Temperature range III: 72°C / 43°C	δ_{N0} - factor	[mm/(N/mm ²)]	0,032	0,037	0,043	0,049	0,055	0,067
	$\delta_{N\infty}$ - factor	[mm/(N/mm ²)]	0,240	0,240	0,240	0,240	0,240	0,240

¹⁾ Calculation of the displacement

$$\delta_{N0} = \delta_{N0}\text{-factor} \cdot \tau; \quad \tau: \text{action bond stress for tension}$$

$$\delta_{N\infty} = \delta_{N\infty}\text{-factor} \cdot \tau;$$

Table C11: Displacements under shear load¹⁾ (internally threaded anchor rod)

Internally threaded anchor rod			IG-M6	IG-M8	IG-M10	IG-M12	IG-M16	IG-M20
Uncracked and cracked concrete C20/25 under static and quasi-static action								
All temperature ranges	δ_{V0} - factor	[mm/(kN)]	0,07	0,06	0,06	0,05	0,04	0,04
	$\delta_{V\infty}$ - factor	[mm/(kN)]	0,10	0,09	0,08	0,08	0,06	0,06

¹⁾ Calculation of the displacement

$$\delta_{V0} = \delta_{V0}\text{-factor} \cdot V; \quad V: \text{action shear load}$$

$$\delta_{V\infty} = \delta_{V\infty}\text{-factor} \cdot V;$$

Injection System VME for concrete

Performance
Displacements (internally threaded anchor rod)

Annex C9

Table C12: Displacements under tension load¹⁾ (rebar)

Reinforcing bar			Ø 8	Ø 10	Ø 12	Ø 14	Ø 16	Ø 20	Ø 25	Ø 28	Ø 32
Uncracked concrete C20/25 under static and quasi-static action											
Temperature range I: 40°C / 24°C	δ_{N0} - factor	[mm/(N/mm ²)]	0,011	0,013	0,015	0,018	0,020	0,024	0,030	0,033	0,037
	$\delta_{N\infty}$ - factor	[mm/(N/mm ²)]	0,044	0,052	0,061	0,070	0,079	0,096	0,118	0,132	0,149
Temperature range II: 60°C / 43°C	δ_{N0} - factor	[mm/(N/mm ²)]	0,013	0,015	0,018	0,020	0,023	0,028	0,034	0,038	0,043
	$\delta_{N\infty}$ - factor	[mm/(N/mm ²)]	0,050	0,060	0,070	0,081	0,091	0,111	0,136	0,151	0,172
Temperature range III: 72°C / 43°C	δ_{N0} - factor	[mm/(N/mm ²)]	0,013	0,015	0,018	0,020	0,023	0,028	0,034	0,038	0,043
	$\delta_{N\infty}$ - factor	[mm/(N/mm ²)]	0,050	0,060	0,070	0,081	0,091	0,111	0,136	0,151	0,172
Cracked concrete C20/25 under static and quasi-static action											
Temperature range I: 40°C / 24°C	δ_{N0} - factor	[mm/(N/mm ²)]	0,032	0,032	0,032	0,035	0,037	0,042	0,049	0,055	0,061
	$\delta_{N\infty}$ - factor	[mm/(N/mm ²)]	0,210	0,210	0,210	0,210	0,210	0,210	0,210	0,210	0,210
Temperature range II: 60°C / 43°C	δ_{N0} - factor	[mm/(N/mm ²)]	0,032	0,032	0,037	0,040	0,043	0,049	0,056	0,063	0,070
	$\delta_{N\infty}$ - factor	[mm/(N/mm ²)]	0,240	0,240	0,240	0,240	0,240	0,240	0,240	0,240	0,240
Temperature range III: 72°C / 43°C	δ_{N0} - factor	[mm/(N/mm ²)]	0,032	0,032	0,037	0,040	0,043	0,049	0,056	0,063	0,070
	$\delta_{N\infty}$ - factor	[mm/(N/mm ²)]	0,240	0,240	0,240	0,240	0,240	0,240	0,240	0,240	0,240

¹⁾ Calculation of the displacement

$$\delta_{N0} = \delta_{N0}\text{-factor} \cdot \tau; \quad \tau: \text{action bond stress for tension}$$

$$\delta_{N\infty} = \delta_{N\infty}\text{-factor} \cdot \tau;$$

Table C13: Displacements under shear load¹⁾ (rebar)

Reinforcing bar			Ø 8	Ø 10	Ø 12	Ø 14	Ø 16	Ø 20	Ø 25	Ø 28	Ø 32
For concrete C20/25 under static and quasi-static action											
All temperature ranges	δ_{V0} - factor	[mm/(kN)]	0,06	0,05	0,05	0,04	0,04	0,04	0,03	0,03	0,03
	$\delta_{V\infty}$ - factor	[mm/(kN)]	0,09	0,08	0,08	0,06	0,06	0,05	0,05	0,04	0,04

¹⁾ Calculation of the displacement

$$\delta_{V0} = \delta_{V0}\text{-factor} \cdot V; \quad V: \text{action shear load}$$

$$\delta_{V\infty} = \delta_{V\infty}\text{-factor} \cdot V;$$

Injection System VME for concrete

Performance
Displacements (rebar)

Annex C10